



WORLD GUTTER SYSTEMS | SLATE AND COPPER SALES™

# Premier Steel Gutter System™ Assembly instructions



PREMIUM QUALITY PRODUCTS  
Div. of SlateAndCopper.com

[www.premiersteelgutters.com](http://www.premiersteelgutters.com)

# Assembly - Roof Drainage System

## Transport, storage, unpacking

Make sure that the roof drainage components are handled with care during transport, storage and unpacking to avoid damage to the painted surface.

## Cutting

Cut the gutters and pipes with hand shears or a hacksaw. Never use an angle grinder or power saw. this will generate heat and destroy the galvanization. the coating may also be scorched by hot chips.

## Touch-up

If the coating has been damaged, touch it up with Premier Steel's repair paint to prolong the lifespan of the roof drainage system.

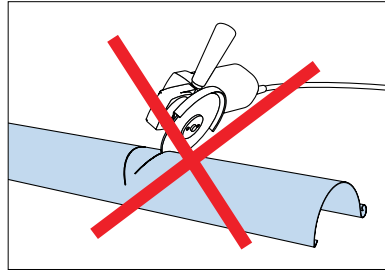

No High speed power tools!

## Maintenance

To keep the roof drainage system in top condition, give the system a good cleaning once a year. Clear the gutter and pipes from leaves and twigs and wash heavy dirt buildup with a mild soap. Dont use high presure power washer.

## Tools

The Premier Steel Gutter Sytem can be installed with ordinary hand tools like pliers, rubber mallet, hacksaw, screwdriver, tape rule and string. for bending hangers, you will need a roof hanger bending tool.

## Fasteners

We recomend that you always use stainless steel screws and use the proper screw for each material. (wood, brick etc.)

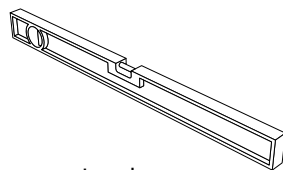

Level



Tape rule

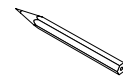

Pencil

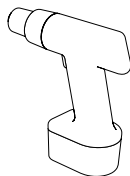

Power screw driver

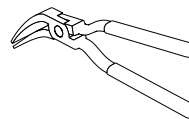

Seam plier

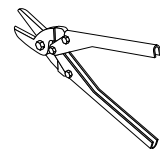

Steel scissors

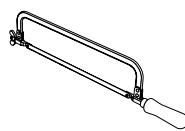

Hack saw

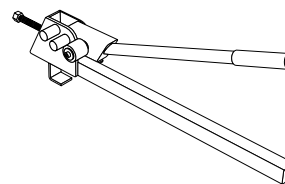

Hanger bending tool

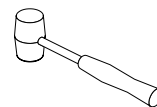

Rubber mallet

# Assembly - Roof Drainage System

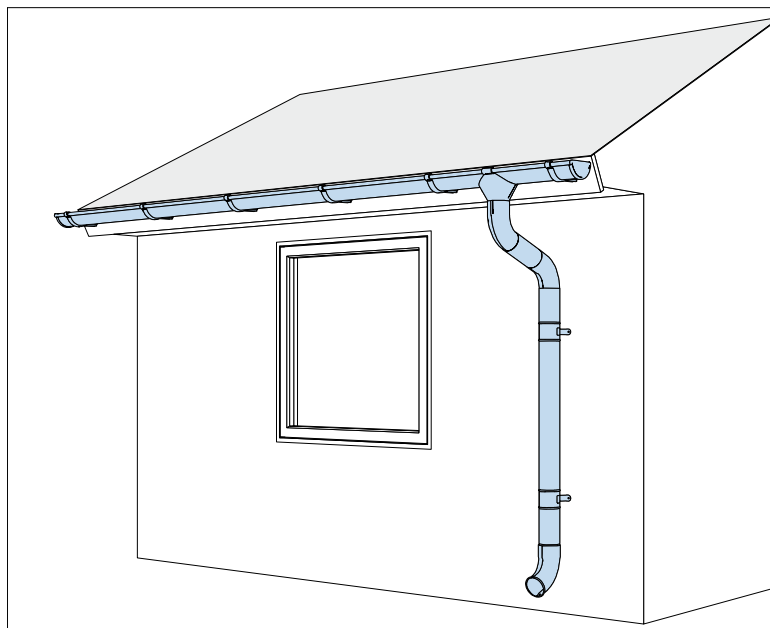
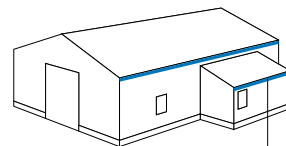

**Roof base**

Depending on the roof construction, different types of hangers can be used. An adjustable type hanger is used in the assembly instructions that follow. on page 16. Other hanger applications are also shown as separate instructions. **The hangers options are as follows:**

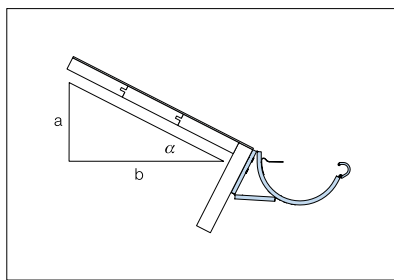

Adjustable heavy duty fascia hanger

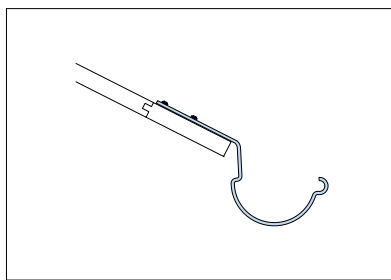

Self locking heavy duty roof hanger

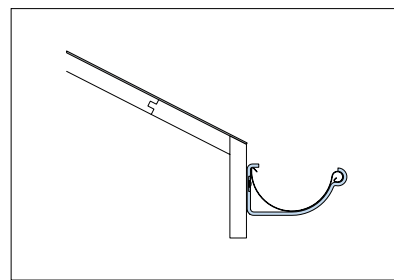

Self locking heavy duty fascia hanger

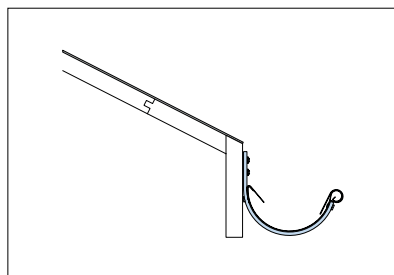

Heavy duty fascia hanger

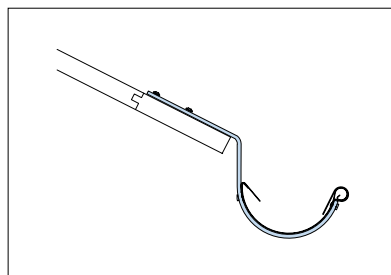

Heavy duty roof hanger

# Assembly - Roof Drainage System

## Adjustable hanger installation

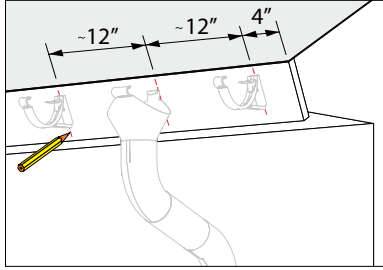

Mark out for the hangers around the downspout.

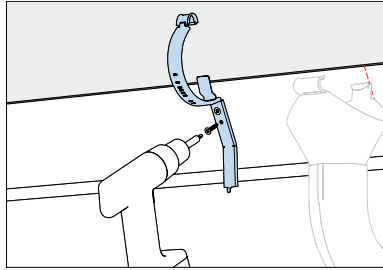

Fasten the "Low Hanger" 12" left of the downspout mark.

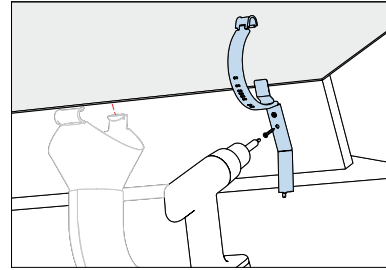

Fasten the hanger to the right of the downspout mark- 1/16" to 1/8" higher than the low hanger.

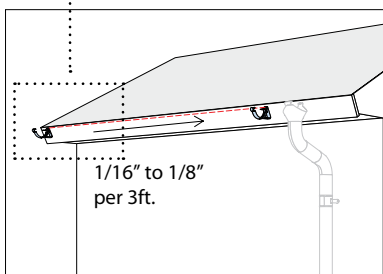

Fasten the "High Hanger" at opposite end of roof base. The slope to pipe should be 1/16" to 1/8" per 3ft.

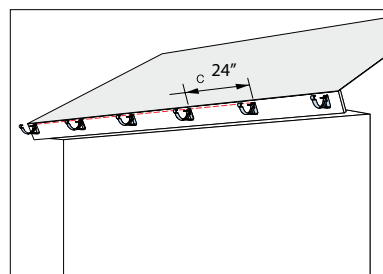

Fasten the other hangers along the string with 24" c/c max.

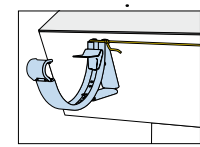

Put a string between the high and low bracket. It will help you to place the other brackets.

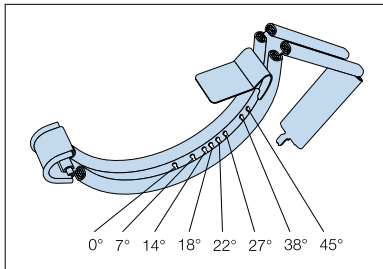

The hanger can now be adjusted

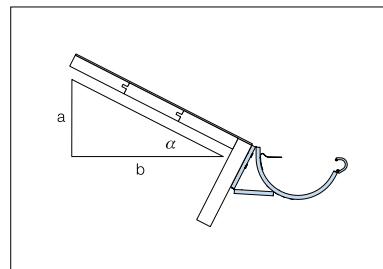

Calculate your roof pitch and adjust the hangers accordingly.

a	b	α
1	1	45°
1	1.25	38°
1	2	27°
1	2.5	22°
1	3	18°
1	4	14°
1	8	7°
1	~	0°

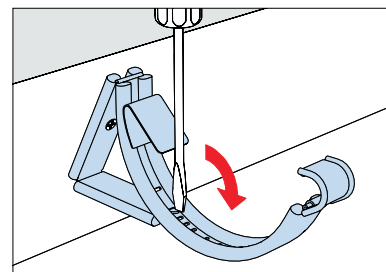
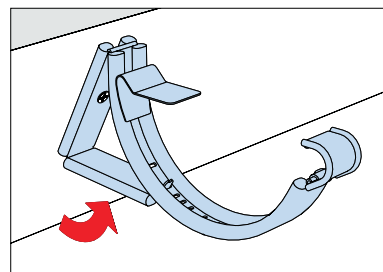
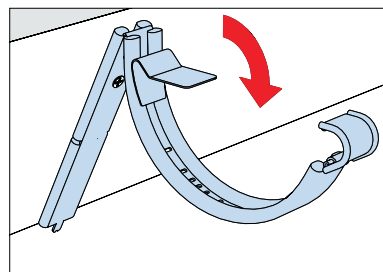

Use a screwdriver to fold the tab forward for low angles and back for angles > 22°

# Assembly - Roof Drainage System

## Gutter assembly

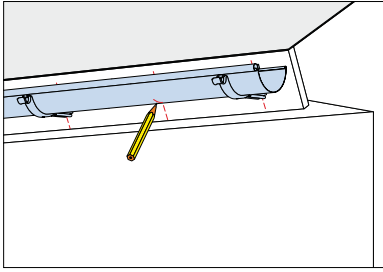

Place gutter in the hangers and mark location of the plug-in outlet

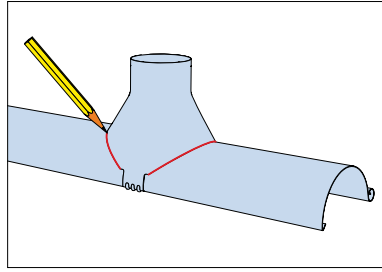

Use the outlet as a template on the gutter

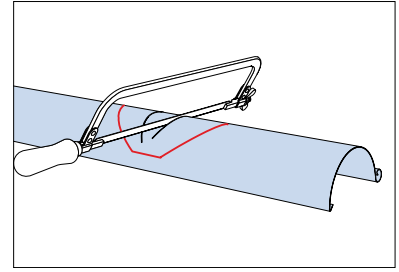

Use a hacksaw to make hole in the gutter

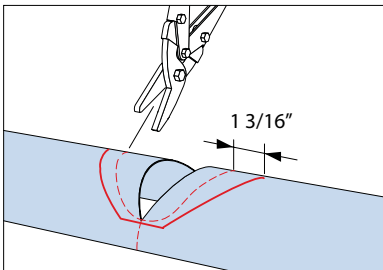

Finish by cutting up to the bead and backside as shown.

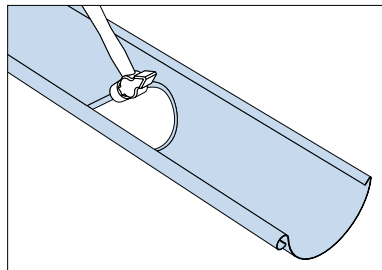

To get a smooth water fall, use a hammer to bevel the edges.

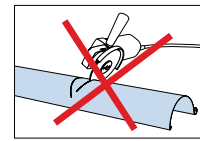

Do not use grinder or power saw, the excessive heat caused by these tools will destroy the galvanization!

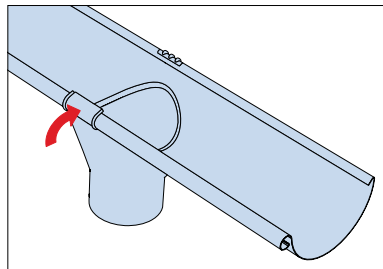

the plug-in outlet easily snaps onto the gutter.

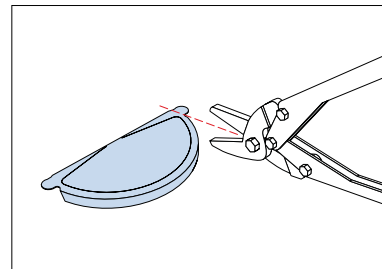

Cut or fold the ear not used.

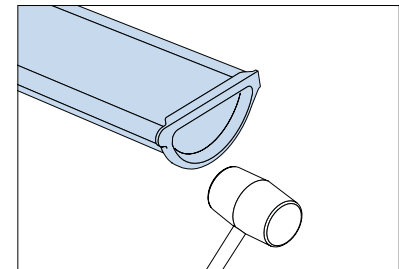

The universal end cap is self sealing. use a rubber hammer to fix it to the gutter.

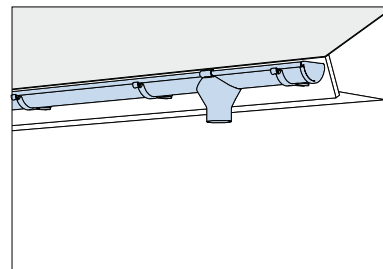

Place the gutter into the rear of the brackets.

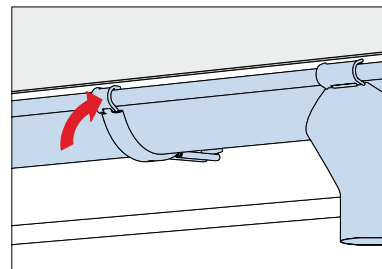

Just snap the bracket closure onto the bead of the gutter.

# Assembly - Roof Drainage System

## Gutter joint

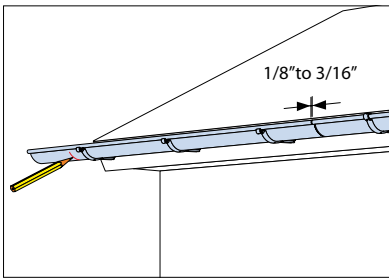

Place the gutter to be joined in the hangers and mark correct length.

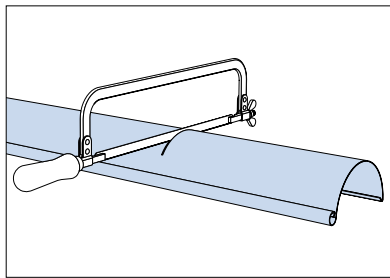

Use a hacksaw to cut the gutter.

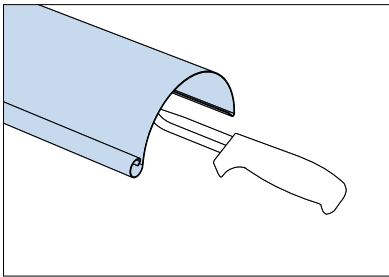

Remove the sharp fillings.

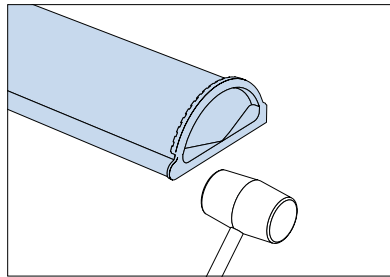

Assemble the end cap.

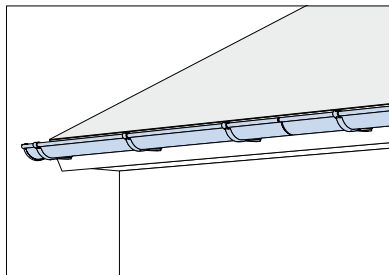

Place gutter in hanger.

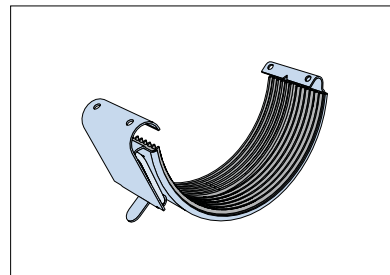

Use self sealing gutter connector

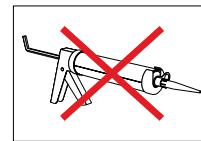

No silicone or sealer should be used.

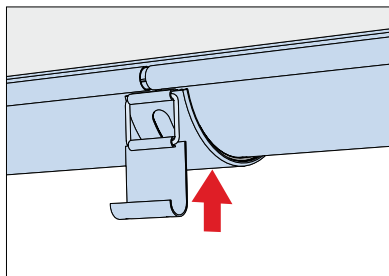

Press the EDPM rubber to the gutter.

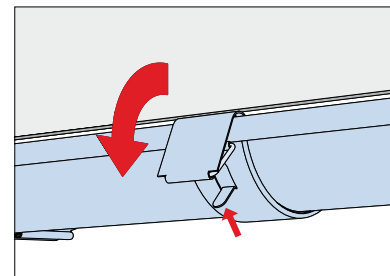

Hook over the bead and snap down.

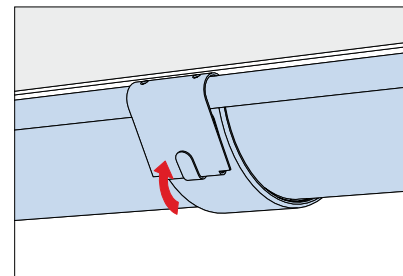

and lock

# Assembly - Roof Drainage System

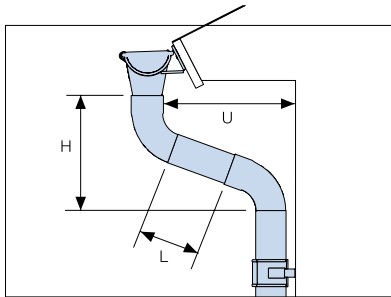

Check measurement "U" to get the length of the bridge pipe. use table on right.

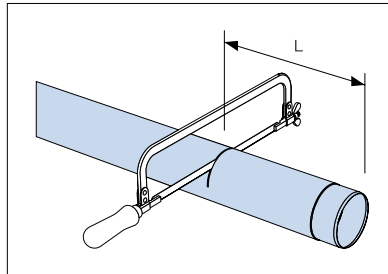

use a hacksaw to cut the bridge pipe. Remove sharp metal burrs!

## Bridge pipe length

70 degree bends

U inches	H inches	L inches
8.66	10.84	0
10.63	11.45	3.94
11.81	11.80	5.31
13.78	12.6	7.28
15.75	13.4	9.45
17.75	13.98	11.42
19.7	14.75	13.58
21.65	15.5	15.75
23.62	16.14	17.91
25.6	16.93	19.88
27.5	17.75	22.05
29.5	18.31	24.02
31.5	19.10	26.18
33.45	19.88	28.35
35.45	20.47	30.31
37.40	21.26	32.48
39.40	21.85	34.65
41.35	22.64	36.61
43.30	23.43	38.78
45.25	24.02	40.94
47.25	24.8	42.91

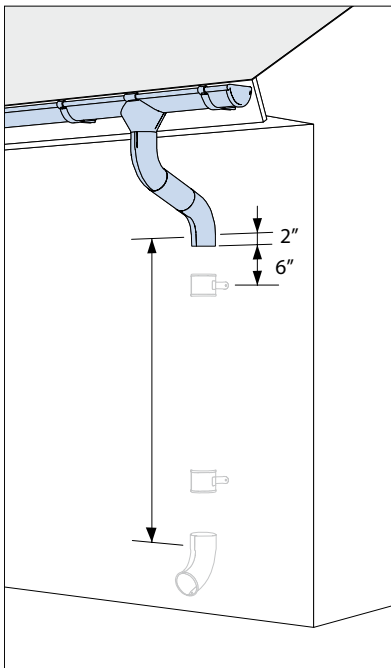

Measure the length of the downspout. Mark out the position of the brackets.

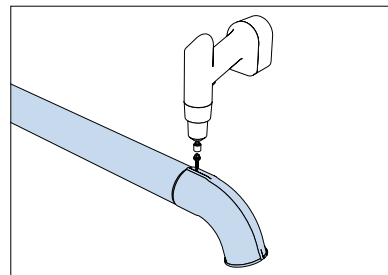

Attach the ground level beaded elbow using self tapping screw on backside.

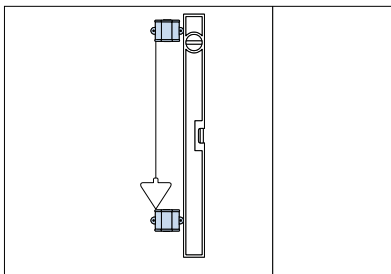

Level the brackets with level or plumb.

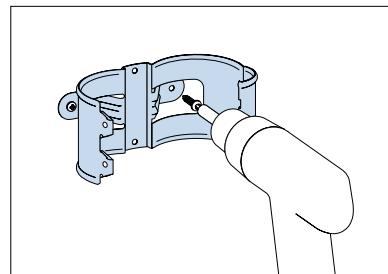

Fasten the brackets to the wall.

# Assembly - Roof Drainage System

## Wide bracket installation

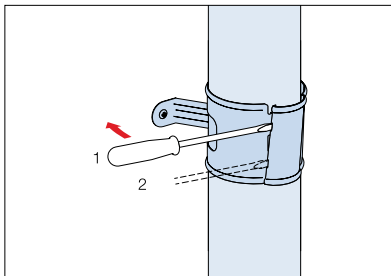
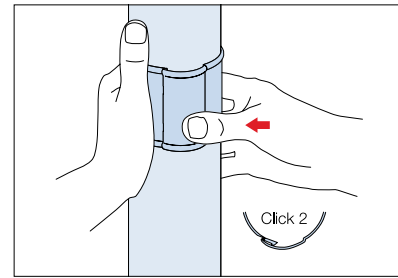
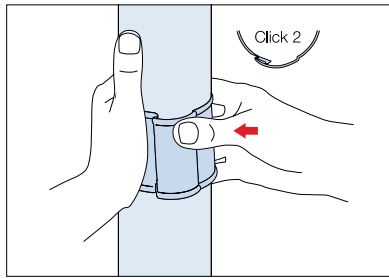
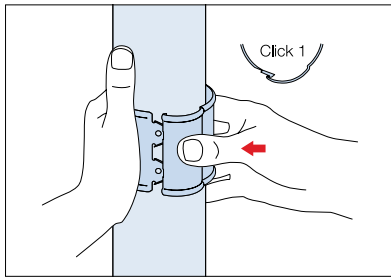

It's easy to dismount the downspout

## Self locking roof hanger

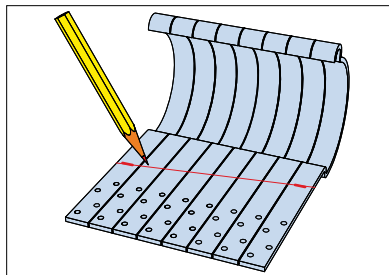
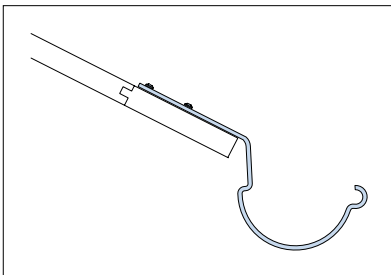

Mark the hangers for gutter incline.  
1/16" per 3'

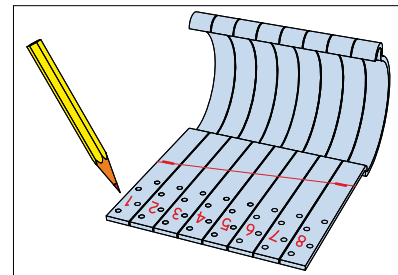

Number the hangers. 1 is the "Low hanger"  
Last number is the "high hanger"

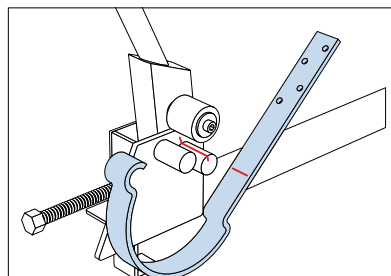

Bend the hangers at themarking

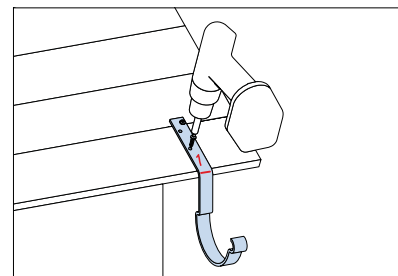
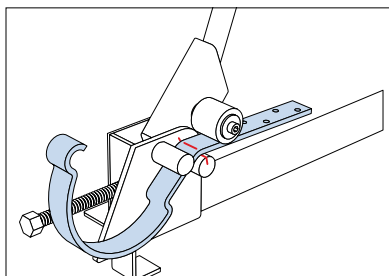

Mount hanger #1 (low hanger) and  
fasten the other hangers at 24" maximum  
spacing



# Assembly - Roof Drainage System

## Self locking heavy duty fascia hanger

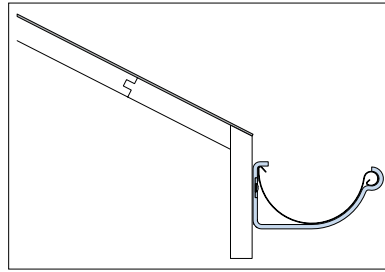

For use with plum fascia board

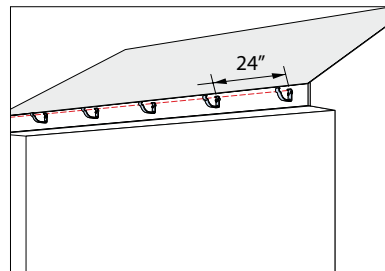
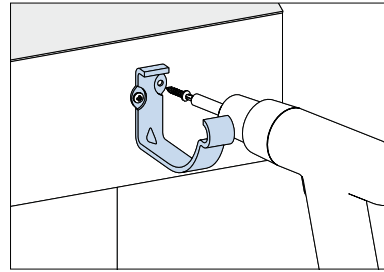

The inclination shall be 1/16" per 3'

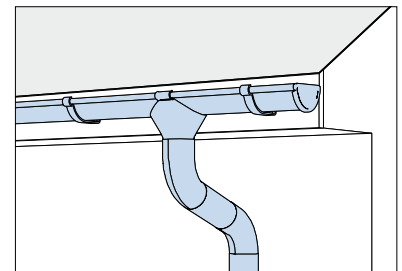
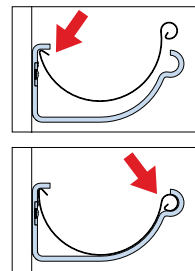

## Heavy duty fascia hanger

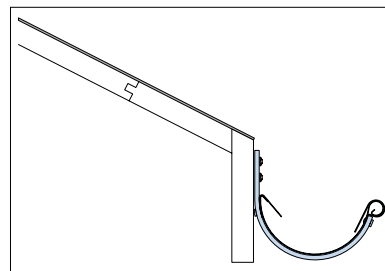

For use with plum fascia board

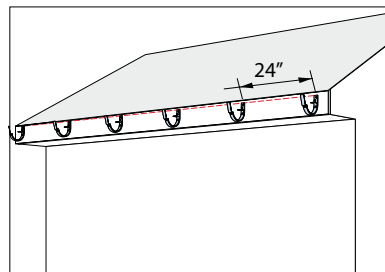
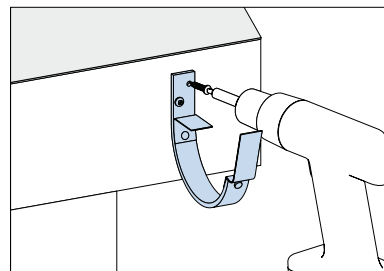

The inclination shall be 1/16" per 3'

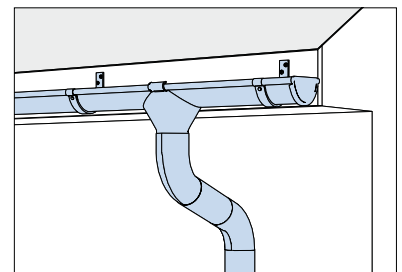
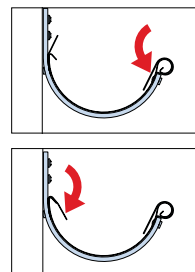

# Assembly - Roof Drainage System

## Traditional gutter joint

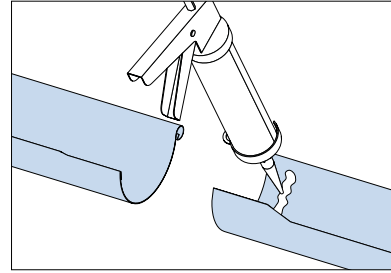
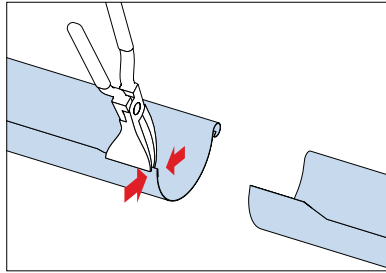
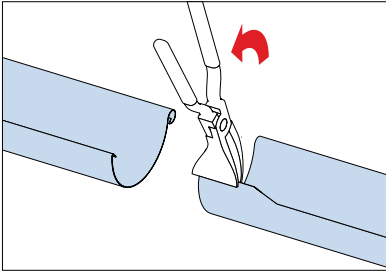

Use a quality silicone sealant

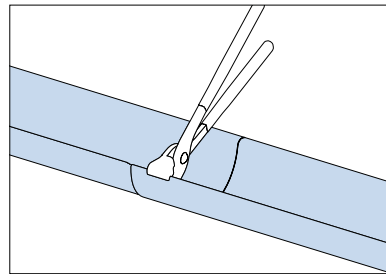
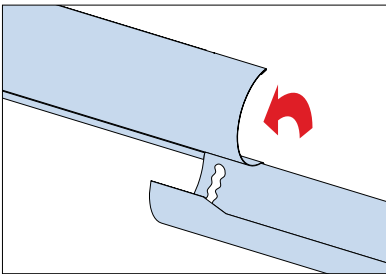

## Traditional flat end cap

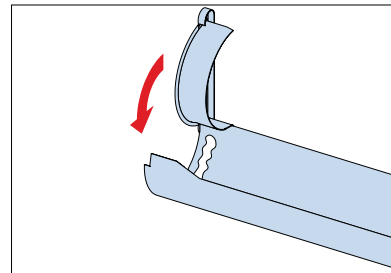
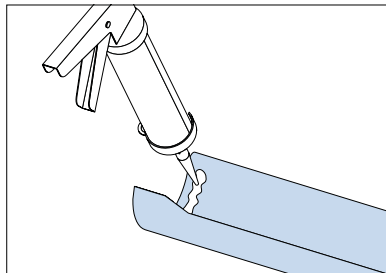
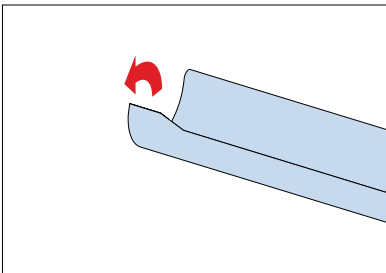

Use a quality silicone sealant

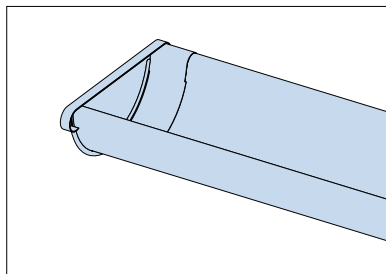
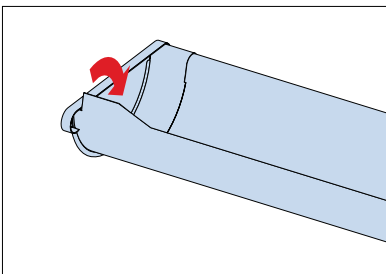

# Assembly - Roof Drainage System

## Overflow protection

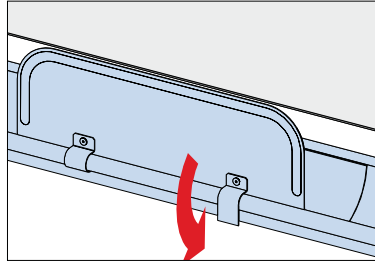

Place overflow protector in gutter

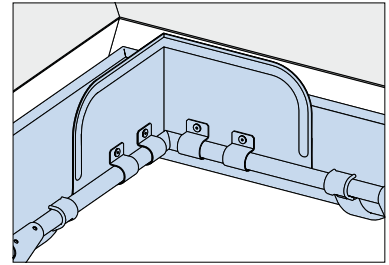

Overflow protection for miters

## Gutter miters

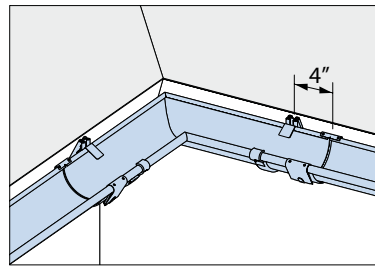

Use gutter connector w/rubber seal

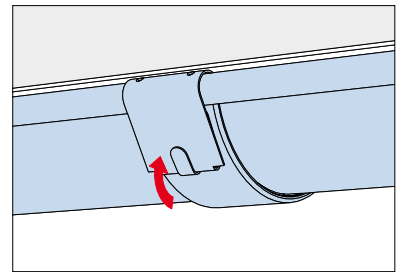

Gutter connector

## Y-pipe

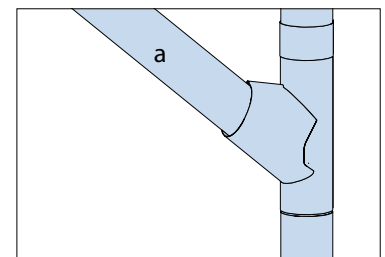
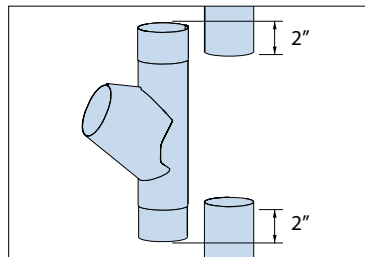

Down-pipe (a) can be mounted in any angle from 50 - 80 degrees

## Stainless steel strainer

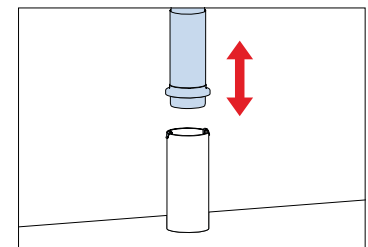
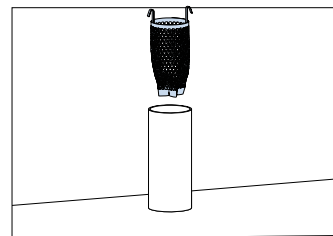

Connect the drain tile extension

## Leaf trap

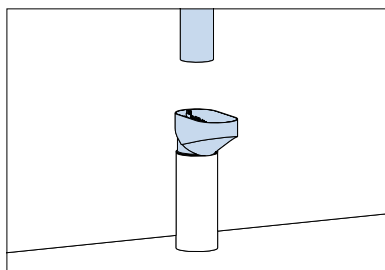

Place the leaf trap in the ground pipe

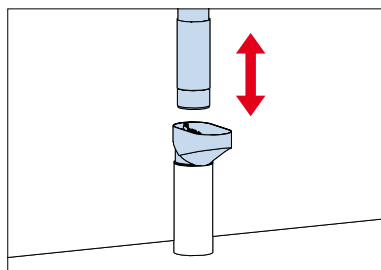

Connect the sliding pipe

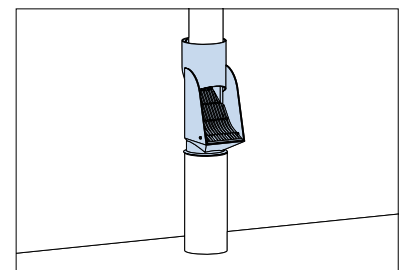

Self cleaning leaf chute also available

# The Complete System

– Prepainted 24 Gauge Galvanized G90

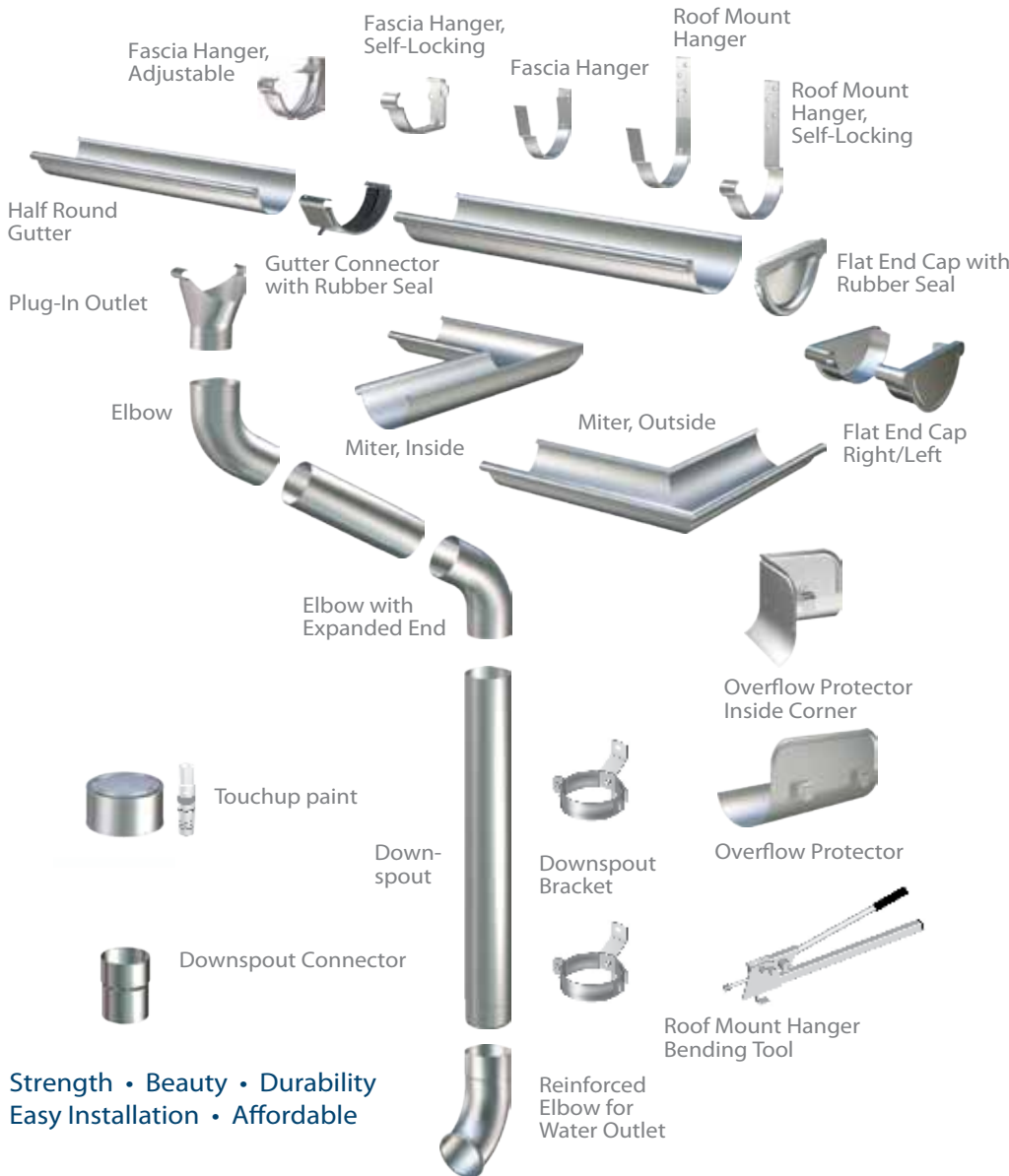

Strength • Beauty • Durability  
Easy Installation • Affordable

## Premier Steel™

-the high performance STEEL rainwater system

Loved by builders,

appreciated by planners

and wanted by clients!!



### WORLD GUTTER SYSTEMS | SLATE AND COPPER SALES

436 West 12th Street, Erie, PA 16501

phone: (814) 455-7430 • fax: (814) 464-8838

sales@slateandcopper.com • www.slateandcopper.com